

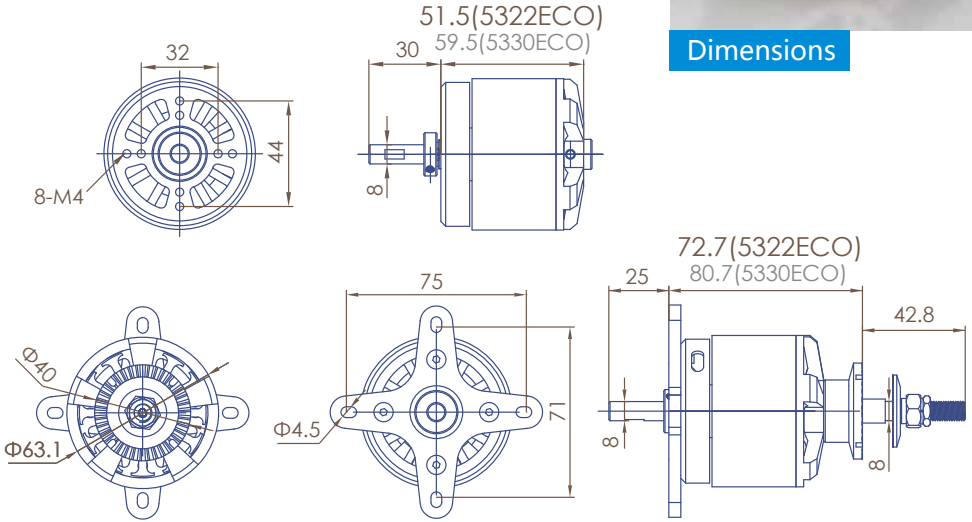

Dimensions

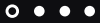

Specification



| ECO-C Series | ECO 5322C | | |
|-----------------------------------|--|--------------------|--------------------|
| SKU(商品编码) | 51679 | 51680 | 51681 |
| KV(KV值) | 430 | 380 | 300 |
| Turns(匝数) | 7 | 8 | 10 |
| Weight(g)(重量) | 510 | 510 | 510 |
| Dimensions(D x L)[mm](尺寸) | 63.1x51.5 | 63.1x51.5 | 63.1x51.5 |
| Slots & Poles(槽数, 极数) | 12N14P | 12N14P | 12N14P |
| Ri(mOhm)(电阻) | 11.5 | 15 | 21.8 |
| I _o @10V (A)(空载电流) | 1.8 | 1.6 | 1.1 |
| No.of Cells(LiPo)(适用电池) | 5.6 | 6 | 8 |
| Max. EfficiencyCurrent[A](效率电流) | 60 | 54 | 48 |
| Max. Burst Current (15S)[A](最大电流) | 100 | 90 | 80 |
| Max. Power(15S)[W](最大功率) | 2400 | 2160 | 2560 |
| Max. Torque [N*M](最大扭矩) | 2.67 | 2.72 | 3.06 |
| Shaft diameter(mm)(轴径) | 8 | 8 | 8 |
| Mountingholes pitch(安装孔距) | 32/44 | 32/44 | 32/44 |
| Input Connectors(输入链接) | GC4.0 | GC4.0 | GC4.0 |
| RecommendedESC(调速器) | XC10036HV | XC10036HV | XC10036HV |
| Propeller(螺旋桨) | 5S: 19x12E, 20x10E 6S: 18x10E, 19x10E | 6S: 19x12E, 20x10E | 8S: 19x10E, 18x12E |
| Class(适用机种) | 1.20 - 1.40 4-stroke.g. Sebart Mythos 125E | | |

ECO 5322C (430KV)

18.5V Motor @ Optimum Efficiency 最佳效率点

Current
55.04
A

Voltage
17.8
V

Revolutions*
7119
rpm

electric Power
979.5
W

mech. Power
901.3
W

Efficiency
92
%

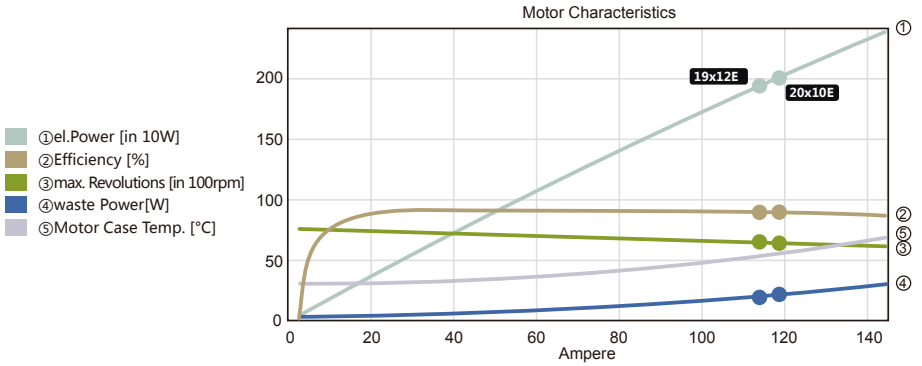

| Voltage (V) | Propeller (RPM) | Throttle (%) | Current (A) | Voltage (V) | el. Power (W) | Efficiency (%) | Thrust (g) | Spec. Thrust (g/W) |
|--------------------|-----------------|--------------|-------------|-------------|---------------|----------------|------------|--------------------|
| 19x12E | | | | | | | | |
| 18.5V (5S LIPO) | 2000 | 27 | 3.5 | 18.5 | 64.3 | 84.2 | 886 | 13.8 |
| | 2400 | 33 | 5.9 | 18.4 | 107.5 | 87.1 | 1276 | 11.9 |
| | 2800 | 38 | 9.2 | 18.4 | 167.5 | 88.7 | 1736 | 10.4 |
| | 3200 | 44 | 13.6 | 18.4 | 247.4 | 89.7 | 2268 | 9.2 |
| | 3600 | 50 | 19.3 | 18.3 | 350.3 | 90.2 | 2870 | 8.2 |
| | 4000 | 57 | 26.6 | 18.2 | 479.3 | 90.4 | 3543 | 7.4 |
| | 4400 | 63 | 35.6 | 18.1 | 637.8 | 90.4 | 4288 | 6.7 |
| | 4800 | 70 | 46.6 | 18 | 828.9 | 90.3 | 5103 | 6.2 |
| | 5200 | 77 | 59.9 | 17.9 | 1056.1 | 90.1 | 5988 | 5.7 |
| | 5600 | 84 | 75.8 | 17.7 | 1322.8 | 89.9 | 6945 | 5.3 |
| | 6000 | 91 | 94.7 | 17.5 | 1632.4 | 89.6 | 7973 | 4.9 |
| | 6400 | 99 | 117 | 17.3 | 1988.5 | 89.2 | 9071 | 4.6 |
| | 6426 | 100 | 118.8 | 17.3 | 2017.8 | 89.1 | 9145 | 4.5 |
| | 20x10E | | | | | | | |
| 18.5V (5S LIPO) | 2000 | 27 | 3.6 | 18.5 | 65.7 | 84.4 | 861 | 13.1 |
| | 2400 | 33 | 6 | 18.4 | 109.8 | 87.2 | 1240 | 11.3 |
| | 2800 | 39 | 9.4 | 18.4 | 171.2 | 88.8 | 1688 | 9.9 |
| | 3200 | 44 | 13.9 | 18.4 | 253 | 89.7 | 2204 | 8.7 |
| | 3600 | 51 | 19.8 | 18.3 | 358.4 | 90.2 | 2790 | 7.8 |
| | 4000 | 57 | 27.2 | 18.2 | 490.7 | 90.3 | 3444 | 7 |
| | 4400 | 63 | 36.5 | 18.1 | 653 | 90.4 | 4167 | 6.4 |
| | 4800 | 70 | 47.8 | 18 | 848.9 | 90.2 | 4960 | 5.8 |
| | 5200 | 77 | 61.4 | 17.9 | 1081.8 | 90 | 5821 | 5.4 |
| | 5600 | 84 | 77.7 | 17.7 | 1355.2 | 89.8 | 6750 | 5 |
| | 6000 | 92 | 97.2 | 17.5 | 1672.7 | 89.4 | 7749 | 4.6 |
| | 6400 | 100 | 120.2 | 17.2 | 2037.9 | 89.1 | 8817 | 4.3 |
| | 6405 | 100 | 120.8 | 17.2 | 2047.4 | 89 | 8831 | 4.3 |

22.2V Motor @ Optimum Efficiency 最佳效率点

Current
64.43
A

Voltage
21.24
V

Revolutions*
8504
rpm

electric Power
1368.6
W

mech. Power
1261.8
W

Efficiency
92.2
%

- ① el. Power [in 20W]
- ② Efficiency [%]
- ③ max. Revolutions [in 100rpm]
- ④ waste Power[W]
- ⑤ Motor Case Temp. [°C]

Motor Characteristics

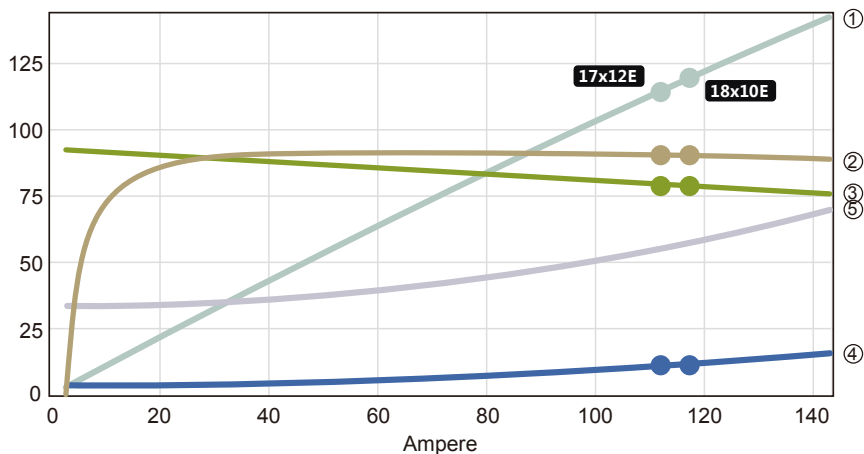

| Voltage (V) | Propeller (RPM) | Throttle (%) | Current (A) | Voltage (V) | el. Power (W) | Efficiency (%) | Thrust (g) | Spec. Thrust (g/W) |
|--------------------|-----------------|--------------|-------------|-------------|---------------|----------------|------------|--------------------|
| 22.2V (6S LIPO) | 17x12E | | | | | | | |
| | 2400 | 27 | 3.2 | 22.2 | 71.5 | 83.8 | 914 | 12.8 |
| | 3000 | 34 | 6.1 | 22.1 | 133.7 | 87.6 | 1428 | 10.7 |
| | 3600 | 41 | 10.3 | 22.1 | 225.9 | 89.6 | 2056 | 9.1 |
| | 4200 | 48 | 16.2 | 22 | 354.5 | 90.7 | 2798 | 7.9 |
| | 4800 | 56 | 24.2 | 21.9 | 526.1 | 91.2 | 3655 | 6.9 |
| | 5400 | 63 | 34.7 | 21.8 | 747.4 | 91.4 | 4626 | 6.2 |
| | 6000 | 71 | 48 | 21.6 | 1025.3 | 91.4 | 5711 | 5.6 |
| | 6600 | 80 | 64.6 | 21.4 | 1366.6 | 91.3 | 6910 | 5.1 |
| | 7200 | 89 | 85.2 | 21.1 | 1778.4 | 91.1 | 8224 | 4.6 |
| | 7800 | 98 | 110.4 | 20.8 | 2268 | 90.8 | 9651 | 4.3 |
| | 7903 | 100 | 115.6 | 20.7 | 2366.9 | 90.6 | 9909 | 4.2 |
| | 18x10E | | | | | | | |
| | 2400 | 27 | 3.4 | 22.2 | 74.5 | 84.3 | 904 | 12.1 |
| | 3000 | 34 | 6.3 | 22.1 | 139.6 | 87.9 | 1412 | 10.1 |
| | 3600 | 41 | 10.8 | 22.1 | 236.2 | 89.8 | 2034 | 8.6 |
| | 4200 | 48 | 17 | 22 | 371.1 | 90.7 | 2768 | 7.5 |
| | 4800 | 56 | 25.4 | 21.9 | 551.2 | 91.2 | 3615 | 6.6 |
| | 5400 | 64 | 36.4 | 21.7 | 783.5 | 91.3 | 4576 | 5.8 |
| | 6000 | 72 | 50.4 | 21.6 | 1075.3 | 91.3 | 5649 | 5.3 |
| 6600 | 80 | 67.9 | 21.3 | 1433.8 | 91.1 | 6836 | 4.8 | |
| 7200 | 89 | 89.7 | 21.1 | 1866.7 | 90.9 | 8135 | 4.4 | |
| 7800 | 99 | 116.4 | 20.7 | 2381.4 | 90.6 | 9547 | 4 | |
| 7857 | 100 | 119.6 | 20.7 | 2441.1 | 90.4 | 9687 | 4 | |

ECO 532C (380KV)

22.2V Motor @ Optimum Efficiency 最佳效率点

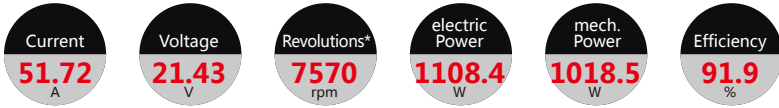

- ① el.Power [in 20W]
- ② Efficiency [%]
- ③ max. Revolutions [in 100rpm]
- ④ waste Power[W]
- ⑤ Motor Case Temp. [°C]

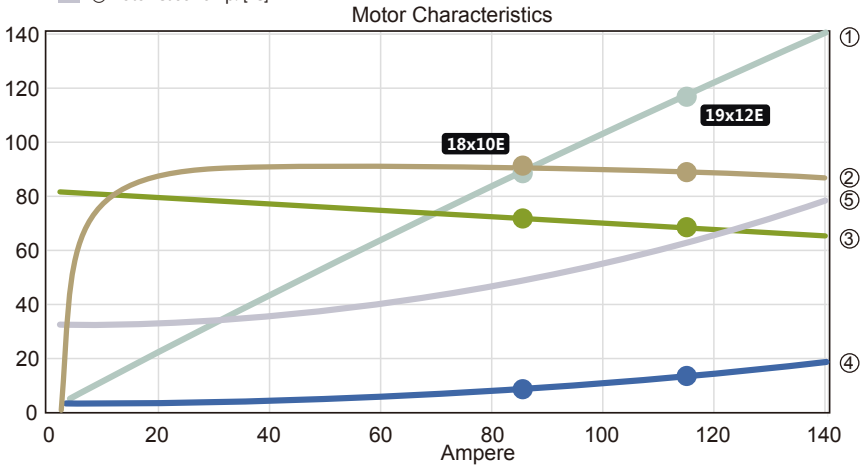

| Voltage (V) | Propeller (RPM) | Throttle (%) | Current (A) | Volage (V) | el. Power (W) | Efficiency (%) | Thrust (g) | Spec. Thrust (g/W) |
|--------------------|-----------------|--------------|-------------|------------|---------------|----------------|------------|--------------------|
| 18x10E | | | | | | | | |
| 22.2V (6S LIPO) | 2500 | 32 | 3.8 | 22.2 | 83.8 | 84.7 | 981 | 11.7 |
| | 3000 | 38 | 6.4 | 22.1 | 140.1 | 87.6 | 1412 | 10.1 |
| | 3500 | 45 | 9.9 | 22.1 | 218.3 | 89.3 | 1922 | 8.8 |
| | 4000 | 52 | 14.7 | 22 | 322.3 | 90.2 | 2511 | 7.8 |
| | 4500 | 59 | 20.9 | 21.9 | 456.1 | 90.8 | 3178 | 7 |
| | 5000 | 66 | 28.8 | 21.8 | 623.8 | 91.1 | 3923 | 6.3 |
| | 5500 | 73 | 38.5 | 21.7 | 829.6 | 91.1 | 4747 | 5.7 |
| | 6000 | 81 | 50.4 | 21.6 | 1077.5 | 91.1 | 5649 | 5.2 |
| | 6500 | 89 | 64.7 | 21.4 | 1372 | 91 | 6630 | 4.8 |
| | 7000 | 97 | 81.9 | 21.2 | 1717.3 | 90.8 | 7689 | 4.5 |
| | 7144 | 100 | 87.6 | 21.1 | 1830.9 | 90.6 | 8009 | 4.4 |
| 19x12E | | | | | | | | |
| 22.2V (6S LIPO) | 2500 | 32 | 5.5 | 22.1 | 121.2 | 87.3 | 1384 | 11.4 |
| | 3000 | 39 | 9.4 | 22.1 | 205.3 | 89 | 1993 | 9.7 |
| | 3500 | 46 | 14.8 | 22 | 323 | 89.9 | 2713 | 8.4 |
| | 4000 | 53 | 22.1 | 21.9 | 480.5 | 90.2 | 3543 | 7.4 |
| | 4500 | 61 | 31.7 | 21.8 | 683.9 | 90.2 | 4485 | 6.6 |
| | 5000 | 68 | 43.9 | 21.6 | 939.9 | 90 | 5537 | 5.9 |
| | 5500 | 77 | 59.1 | 21.5 | 1255 | 89.7 | 6699 | 5.3 |
| | 6000 | 85 | 78 | 21.2 | 1636.1 | 89.4 | 7973 | 4.9 |
| | 6500 | 94 | 101.1 | 20.9 | 2090.1 | 89 | 9357 | 4.5 |
| | 6793 | 100 | 117.3 | 20.7 | 2398.6 | 88.6 | 10219 | 4.3 |

ECO 532C (300KV)

29.6V Motor @ Optimum Efficiency 最佳效率点

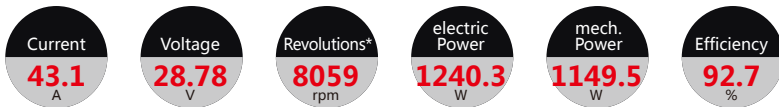

- ① el. Power [in 20W]
- ② Efficiency [%]
- ③ max. Revolutions [in 100rpm]
- ④ waste Power[W]
- ⑤ Motor Case Temp. [°C]

Motor Characteristics

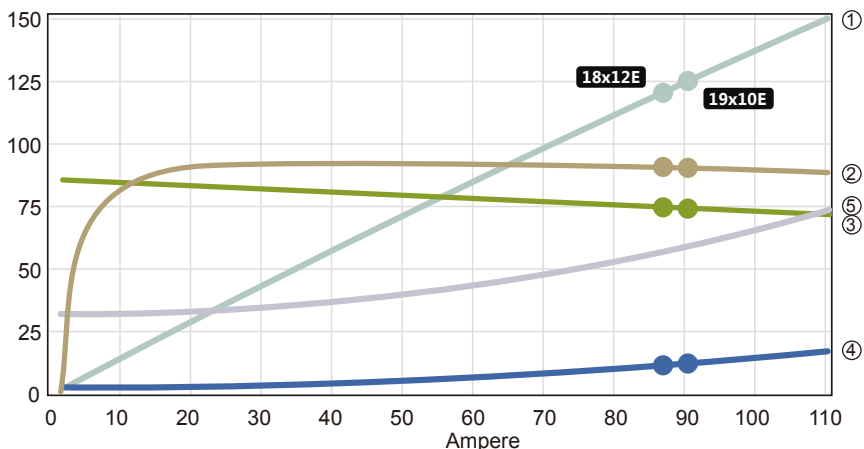

| Voltage (V) | Propeller (RPM) | Throttle (%) | Current (A) | Volage (V) | el. Power (W) | Efficiency (%) | Thrust (g) | Spec. Thrust (g/W) |
|--------------------|-----------------|--------------|-------------|------------|---------------|----------------|------------|--------------------|
| 29.6V (8S LIPO) | 18x12E | | | | | | | |
| | 2500 | 30 | 3.3 | 29.5 | 97.5 | 87.4 | 1177 | 12.1 |
| | 3000 | 36 | 5.6 | 29.5 | 164.5 | 89.5 | 1695 | 10.3 |
| | 3500 | 43 | 8.8 | 29.5 | 257.9 | 90.7 | 2307 | 8.9 |
| | 4000 | 49 | 13.1 | 29.4 | 382.4 | 91.3 | 3013 | 7.9 |
| | 4500 | 56 | 18.6 | 29.3 | 542.9 | 91.5 | 3813 | 7 |
| | 5000 | 63 | 25.6 | 29.2 | 744.3 | 91.6 | 4708 | 6.3 |
| | 5500 | 70 | 34.4 | 29 | 991.6 | 91.5 | 5696 | 5.7 |
| | 6000 | 77 | 45 | 28.8 | 1289.9 | 91.3 | 6779 | 5.3 |
| | 6500 | 85 | 57.8 | 28.6 | 1644.5 | 91.1 | 7956 | 4.8 |
| | 7000 | 92 | 73.1 | 28.4 | 2060.6 | 90.8 | 9227 | 4.5 |
| | 7458 | 100 | 89.9 | 28.1 | 2505.9 | 90.4 | 10475 | 4.2 |
| | 19x10E | | | | | | | |
| | 3000 | 36 | 5.8 | 29.5 | 170 | 89.6 | 1661 | 9.8 |
| | 3500 | 43 | 9.1 | 29.4 | 266.7 | 90.7 | 2261 | 8.5 |
| | 4000 | 49 | 13.5 | 29.4 | 395.6 | 91.3 | 2953 | 7.5 |
| | 4500 | 56 | 19.3 | 29.3 | 561.9 | 91.5 | 3737 | 6.7 |
| | 5000 | 63 | 26.6 | 29.2 | 770.7 | 91.5 | 4614 | 6 |
| | 5500 | 70 | 35.6 | 29 | 1027.1 | 91.4 | 5583 | 5.4 |
| | 6000 | 77 | 46.7 | 28.8 | 1336.5 | 91.2 | 6644 | 5 |
| 6500 | 85 | 60 | 28.6 | 1704.2 | 90.9 | 7798 | 4.6 | |
| 7000 | 93 | 76 | 28.3 | 2136 | 90.6 | 9043 | 4.2 | |
| 7428 | 100 | 92.2 | 28.1 | 2566.5 | 90.2 | 10184 | 4 | |



ECO 5330C-V2

Dimensions

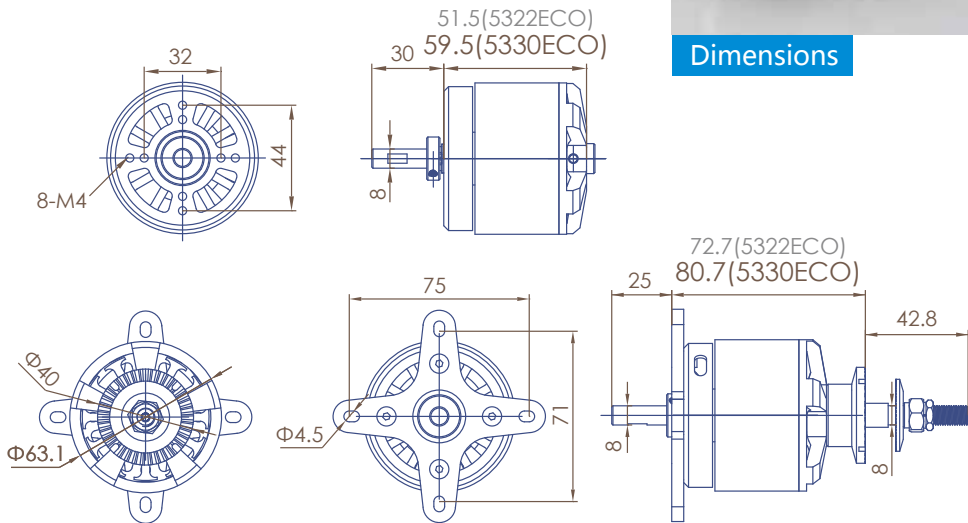

Specification

| ECO-C Series | ECO 5330C | | |
|-----------------------------------|--|--------------------------------|---|
| SKU(商品编码) | 51682 | 51683 | 51684 |
| KV(KV值) | 280 | 225 | 205 |
| Turns(匝数) | 8 | 10 | 11 |
| Weight(g)(重量) | 640 | 640 | 640 |
| Dimensions(D x L)[mm](尺寸) | 63.1x59.5 | 63.1x59.5 | 63.1x59.5 |
| Slots & Poles(槽数, 极数) | 12N14P | 12N14P | 12N14P |
| Ri(mOhm)(电阻) | 17.8 | 36.2 | 43.0 |
| I _o @10V (A)(空载电流) | 1.4 | 1.0 | 0.8 |
| No.of Cells(LiPo)(适用电池) | 8 | 10 | 10.12 |
| Max. EfficiencyCurrent[A](效率电流) | 60 | 55 | 50 |
| Max. Burst Current (15S)[A](最大电流) | 100 | 90 | 85 |
| Max. Power(15S)[W](最大功率) | 3200 | 3600 | 3400 |
| Max. Torque [N*M](最大扭矩) | 4.10 | 4.59 | 4.76 |
| Shaft diameter(mm)(轴径) | 8 | 8 | 8 |
| Mountingholes pitch(安装孔距) | 32/44 | 32/44 | 32/44 |
| Input Connectors(输入链接) | GC4.0 | GC4.0 | GC4.0 |
| RecommendedESC(调速器) | XC10036HV | XC10036HV | XC10036HV |
| Propeller(螺旋桨) | 8S: 20x13E, 22x10E | 10S: 20.5x12WE, 21x13E, 22x10E | 10S: 20.5x12WE, 21x13E, 21x14E 12S: 19x10E, 19x12E |
| Class(适用机种) | 1.40 - 1.80 4-stroke e.g. FAI, F3A & popular 78° 3D models | | |

ECO 5330C (280KV)

29.6V Motor @ Optimum Efficiency 最佳效率点

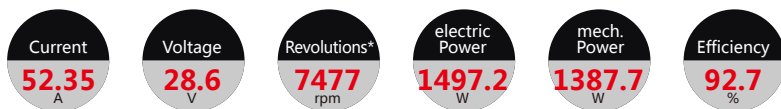

- ① el. Power [in 20W]
- ② Efficiency [%]
- ③ max. Revolutions [in 100rpm]
- ④ waste Power[W]
- ⑤ Motor Case Temp. [°C]

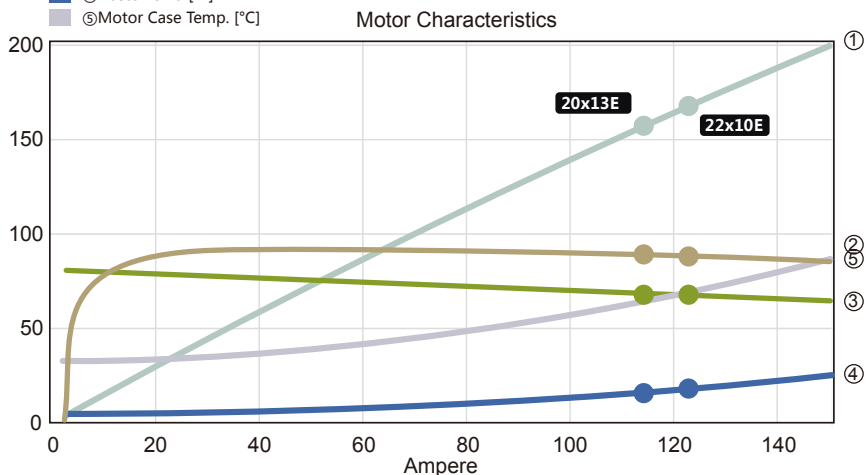

| Voltage (V) | Propeller (RPM) | Throttle (%) | Current (A) | Volage (V) | el. Power (W) | Efficiency (%) | Thrust (g) | Spec. Thrust (g/W) | |
|----------------------------|-----------------|--------------|-------------|------------|---------------|----------------|------------|--------------------|--|
| 20x13E | | | | | | | | | |
| 29.6V (8S LIPO) | 2000 | 26 | 2.9 | 29.6 | 84.7 | 85.1 | 1119 | 13.2 | |
| | 2500 | 32 | 5.4 | 29.5 | 159.2 | 88.4 | 1749 | 11 | |
| | 3000 | 39 | 9.2 | 29.4 | 269.9 | 90.1 | 2519 | 9.3 | |
| | 3500 | 46 | 14.5 | 29.4 | 424.7 | 90.9 | 3428 | 8.1 | |
| | 4000 | 54 | 21.7 | 29.2 | 631.6 | 91.2 | 4477 | 7.1 | |
| | 4500 | 61 | 31.1 | 29.1 | 898.7 | 91.3 | 5667 | 6.3 | |
| | 5000 | 69 | 43.1 | 28.9 | 1234.4 | 91.2 | 6996 | 5.7 | |
| | 5500 | 77 | 58 | 28.6 | 1647.2 | 91 | 8465 | 5.1 | |
| | 6000 | 85 | 76.4 | 28.3 | 2145.8 | 90.6 | 10074 | 4.7 | |
| | 6500 | 94 | 99 | 27.9 | 2739.1 | 90.3 | 11823 | 4.3 | |
| | 6802 | 100 | 115.1 | 27.7 | 3153.8 | 90 | 12948 | 4.1 | |
| | 22x10E | | | | | | | | |
| | 2500 | 33 | 6.1 | 29.5 | 178.3 | 88.9 | 1791 | 10 | |
| | 3000 | 40 | 10.4 | 29.4 | 303.4 | 90.2 | 2579 | 8.5 | |
| 3500 | 47 | 16.4 | 29.3 | 478.6 | 90.8 | 3510 | 7.3 | | |
| 4000 | 54 | 24.6 | 29.2 | 713 | 91 | 4584 | 6.4 | | |
| 4500 | 62 | 35.3 | 29 | 1016.1 | 90.9 | 5802 | 5.7 | | |
| 5000 | 70 | 49 | 28.8 | 1397.4 | 90.7 | 7163 | 5.1 | | |
| 5500 | 78 | 66.1 | 28.5 | 1866.8 | 90.4 | 8667 | 4.6 | | |
| 6000 | 87 | 87.4 | 28.1 | 2434.4 | 90 | 10314 | 4.2 | | |
| 6500 | 96 | 113.5 | 27.7 | 3110.6 | 89.5 | 12105 | 3.9 | | |
| 6692 | 100 | 125.3 | 27.5 | 3409 | 89.3 | 12832 | 3.8 | | |

ECO 5330C (225KV)

37V Motor @ Optimum Efficiency 最佳效率点

Current
35.4
A

Voltage
36.18
V

Revolutions*
7573
rpm

electric Power
1280.5
W

mech. Power
1178.8
W

Efficiency
92.1
%

Motor Characteristics

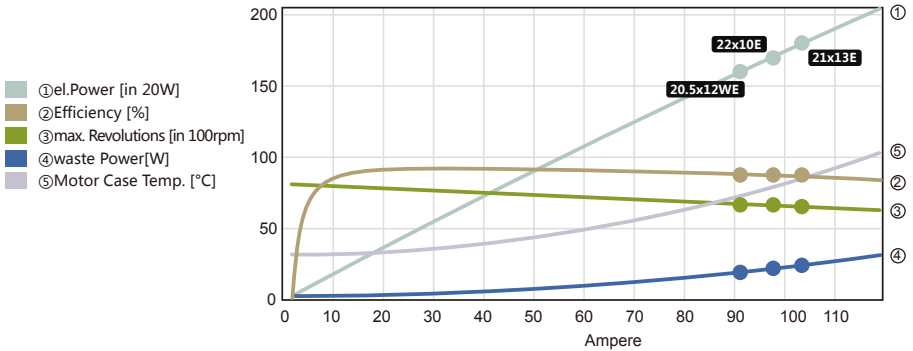

| Voltage (V) | Propeller (RPM) | Throttle (%) | Current (A) | Voltage (V) | el. Power (W) | Efficiency (%) | Thrust (g) | Spec. Thrust (g/W) |
|------------------|-----------------|--------------|-------------|-------------|---------------|----------------|------------|--------------------|
| 20.5x12WE | | | | | | | | |
| 3000 | 40 | 40 | 7.5 | 36.8 | 276.9 | 89.5 | 2504 | 9 |
| 3500 | 47 | 47 | 11.9 | 36.7 | 437.3 | 90 | 3408 | 7.8 |
| 4000 | 54 | 54 | 17.9 | 36.6 | 652.2 | 90 | 4451 | 6.8 |
| 4500 | 62 | 62 | 25.6 | 36.5 | 930.6 | 89.8 | 5633 | 6.1 |
| 5000 | 69 | 69 | 35.5 | 36.3 | 1281.4 | 89.5 | 6954 | 5.4 |
| 5500 | 78 | 78 | 47.9 | 36 | 1713.8 | 89.1 | 8415 | 4.9 |
| 6000 | 86 | 86 | 63.1 | 35.7 | 2237.6 | 88.6 | 10014 | 4.5 |
| 6500 | 95 | 95 | 81.6 | 35.3 | 2862.3 | 88 | 11753 | 4.1 |
| 6759 | 100 | 100 | 92.9 | 35 | 3235.9 | 87.6 | 12706 | 3.9 |
| 22x10E | | | | | | | | |
| 3000 | 40 | 40 | 8.3 | 36.8 | 306.1 | 89.4 | 2579 | 8.4 |
| 3500 | 47 | 47 | 13.2 | 36.7 | 484.5 | 89.7 | 3510 | 7.2 |
| 4000 | 54 | 54 | 19.9 | 36.6 | 723.8 | 89.7 | 4584 | 6.3 |
| 4500 | 62 | 62 | 28.5 | 36.4 | 1034.2 | 89.4 | 5802 | 5.6 |
| 5000 | 70 | 70 | 39.6 | 36.2 | 1425.7 | 88.9 | 7163 | 5 |
| 5500 | 79 | 79 | 53.5 | 35.9 | 1909 | 88.4 | 8667 | 4.5 |
| 6000 | 87 | 87 | 70.7 | 35.5 | 2494.8 | 87.8 | 10314 | 4.1 |
| 6500 | 97 | 97 | 91.7 | 35.1 | 3194.4 | 87.2 | 12105 | 3.8 |
| 6662 | 100 | 100 | 99.7 | 34.9 | 3456.3 | 86.9 | 12718 | 3.7 |
| 21x13E | | | | | | | | |
| 3000 | 40 | 40 | 9 | 36.8 | 330.7 | 89.4 | 2915 | 8.8 |
| 3500 | 47 | 47 | 14.3 | 36.7 | 524.1 | 89.5 | 3968 | 7.6 |
| 4000 | 55 | 55 | 21.6 | 36.5 | 784.1 | 89.3 | 5183 | 6.6 |
| 4500 | 63 | 63 | 31 | 36.3 | 1121.5 | 88.9 | 6560 | 5.8 |
| 5000 | 71 | 71 | 43.1 | 36.1 | 1547.5 | 88.4 | 8099 | 5.2 |
| 5500 | 79 | 79 | 58.3 | 35.8 | 2073.9 | 87.8 | 9799 | 4.7 |
| 6000 | 89 | 89 | 77.2 | 35.4 | 2712.5 | 87.2 | 11662 | 4.3 |
| 6500 | 98 | 98 | 100.3 | 34.9 | 3475.7 | 86.5 | 13687 | 3.9 |
| 6586 | 100 | 100 | 105 | 34.8 | 3629.6 | 86.3 | 14052 | 3.9 |

37V
(10S LIPO)

ECO 5330C (205KV)

37V Motor @ Optimum Efficiency 最佳效率点

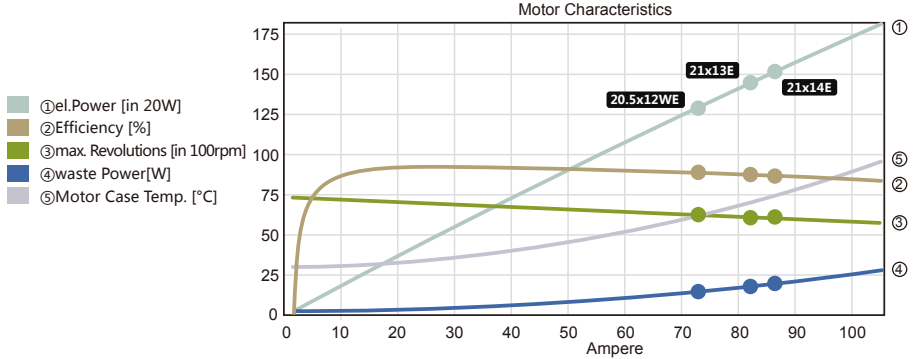
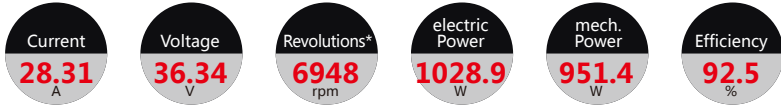

| Voltage (V) | Propeller (RPM) | Throttle (%) | Current (A) | Volage (V) | el. Power (W) | Efficiency (%) | Thrust (g) | Spec. Thrust (g/W) |
|-------------------|-----------------|--------------|-------------|------------|---------------|----------------|------------|--------------------|
| 20.5x12WE | | | | | | | | |
| 37V (10S LIPO) | 2800 | 40 | 6.1 | 36.9 | 224.2 | 89.8 | 2181 | 9.7 |
| | 3200 | 46 | 9.1 | 36.8 | 332.8 | 90.3 | 2848 | 8.6 |
| | 3600 | 53 | 12.9 | 36.7 | 472.9 | 90.5 | 3605 | 7.6 |
| | 4000 | 59 | 17.8 | 36.6 | 649 | 90.5 | 4451 | 6.9 |
| | 4400 | 66 | 23.8 | 36.5 | 865.6 | 90.3 | 5385 | 6.2 |
| | 4800 | 73 | 31.1 | 36.3 | 1127.2 | 90 | 6409 | 5.7 |
| | 5200 | 80 | 39.9 | 36.2 | 1438.5 | 89.7 | 7522 | 5.2 |
| | 5600 | 87 | 50.4 | 35.9 | 1804.5 | 89.3 | 8723 | 4.8 |
| | 6000 | 94 | 62.8 | 35.7 | 2229.9 | 88.9 | 10014 | 4.5 |
| | 6295 | 100 | 73.4 | 35.5 | 2589.9 | 88.5 | 11025 | 4.3 |
| 21x13E | | | | | | | | |
| 37V (10S LIPO) | 2800 | 41 | 7.3 | 36.8 | 267.6 | 89.8 | 2540 | 9.5 |
| | 3200 | 47 | 10.9 | 36.8 | 398.4 | 90 | 3317 | 8.3 |
| | 3600 | 53 | 15.5 | 36.7 | 567.6 | 90 | 4198 | 7.4 |
| | 4000 | 60 | 21.4 | 36.5 | 780.6 | 89.7 | 5183 | 6.6 |
| | 4400 | 67 | 28.8 | 36.4 | 1043 | 89.4 | 6272 | 6 |
| | 4800 | 74 | 37.7 | 36.2 | 1360.5 | 89 | 7464 | 5.5 |
| | 5200 | 81 | 48.6 | 36 | 1739.1 | 88.5 | 8759 | 5 |
| | 5600 | 89 | 61.5 | 35.7 | 2184.7 | 88 | 10159 | 4.7 |
| | 6000 | 97 | 76.8 | 35.4 | 2703.4 | 87.4 | 11662 | 4.3 |
| | 6150 | 100 | 83.4 | 35.2 | 2924.1 | 87.2 | 12254 | 4.2 |
| 21x14E | | | | | | | | |
| 37V (10S LIPO) | 2800 | 41 | 7.9 | 36.8 | 288.4 | 89.7 | 2735 | 9.5 |
| | 3200 | 47 | 11.7 | 36.8 | 430 | 89.8 | 3572 | 8.3 |
| | 3600 | 54 | 16.8 | 36.6 | 613.3 | 89.7 | 4521 | 7.4 |
| | 4000 | 61 | 23.2 | 36.5 | 844.2 | 89.4 | 5582 | 6.6 |
| | 4400 | 67 | 31.2 | 36.3 | 1129 | 88.9 | 6754 | 6 |
| | 4800 | 75 | 41 | 36.1 | 1473.8 | 88.4 | 8038 | 5.5 |
| | 5200 | 82 | 52.8 | 35.9 | 1885.2 | 87.9 | 9433 | 5 |
| | 5600 | 90 | 66.9 | 35.6 | 2369.7 | 87.4 | 10940 | 4.6 |
| | 6000 | 98 | 83.7 | 35.2 | 2934.2 | 86.8 | 12559 | 4.3 |
| | 6086 | 100 | 87.9 | 35.2 | 3071.8 | 86.6 | 12920 | 4.2 |

44.4V Motor @ Optimum Efficiency 最佳效率点

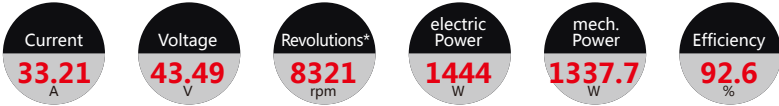

- ① el.Power [in 20W]
- ② Efficiency [%]
- ③ max. Revolutions [in 100rpm]
- ④ waste Power[W]
- ⑤ Motor Case Temp. [°C]

Motor Characteristics

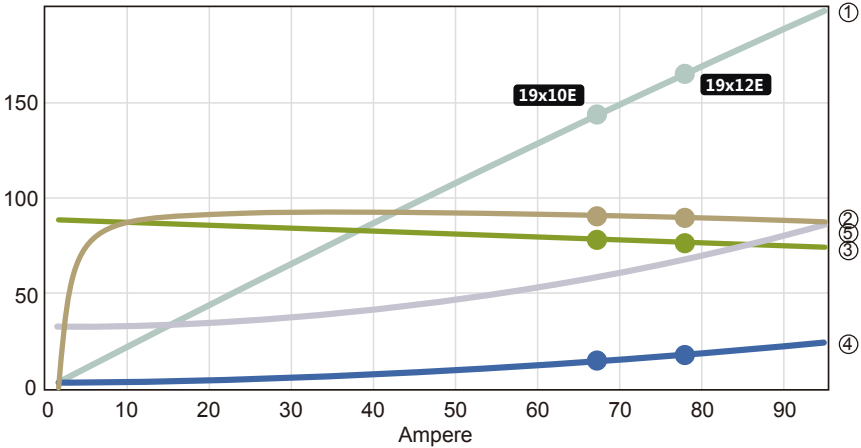

| Voltage (V) | Propeller (RPM) | Throttle (%) | Current (A) | Volage (V) | el. Power (W) | Efficiency (%) | Thrust (g) | Spec. Thrust (g/W) |
|---------------------|-----------------|--------------|-------------|------------|---------------|----------------|------------|--------------------|
| 19x10E | | | | | | | | |
| 44.4V (12S LIPO) | 3000 | 35 | 3.9 | 44.3 | 170.7 | 89.3 | 1661 | 9.7 |
| | 3500 | 41 | 6 | 44.2 | 267.2 | 90.5 | 2261 | 8.5 |
| | 4000 | 48 | 9 | 44.2 | 395.8 | 91.2 | 2953 | 7.5 |
| | 4500 | 54 | 12.8 | 44.1 | 561.6 | 91.5 | 3737 | 6.7 |
| | 5000 | 61 | 17.5 | 44 | 769.4 | 91.7 | 4614 | 6 |
| | 5500 | 67 | 23.5 | 43.8 | 1024.6 | 91.6 | 5583 | 5.4 |
| | 6000 | 74 | 30.6 | 43.6 | 1332.3 | 91.5 | 6644 | 5 |
| | 6500 | 81 | 39.2 | 43.4 | 1697.9 | 91.3 | 7798 | 4.6 |
| | 7000 | 88 | 49.5 | 43.2 | 2126.8 | 91 | 9043 | 4.3 |
| | 7500 | 96 | 61.5 | 42.9 | 2624.4 | 90.7 | 10381 | 4 |
| | 7773 | 100 | 69 | 42.7 | 2933.2 | 90.4 | 11150 | 3.8 |
| | 19x12E | | | | | | | |
| 3000 | 36 | 4.6 | 44.3 | 203.5 | 89.8 | 1993 | 9.8 | |
| 3500 | 42 | 7.2 | 44.2 | 319.9 | 90.7 | 2713 | 8.5 | |
| 4000 | 48 | 10.8 | 44.1 | 475.3 | 91.2 | 3543 | 7.5 | |
| 4500 | 55 | 15.4 | 44 | 676 | 91.3 | 4485 | 6.6 | |
| 5000 | 61 | 21.2 | 43.9 | 928 | 91.2 | 5537 | 6 | |
| 5500 | 68 | 28.4 | 43.7 | 1237.9 | 91 | 6699 | 5.4 | |
| 6000 | 75 | 37.2 | 43.5 | 1612.1 | 90.7 | 7973 | 4.9 | |
| 6500 | 83 | 47.8 | 43.2 | 2057.3 | 90.4 | 9357 | 4.5 | |
| 7000 | 90 | 60.4 | 42.9 | 2580.3 | 90 | 10852 | 4.2 | |
| 7500 | 98 | 75.3 | 42.5 | 3187.9 | 89.6 | 12458 | 3.9 | |
| 7615 | 100 | 79.3 | 42.4 | 3348.1 | 89.4 | 12843 | 3.8 | |