

THE IGNITION ICU-S, ICU-P ver. 2.0

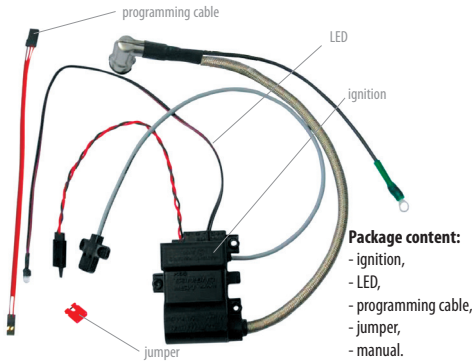

Package content:
- ignition,
- LED,
- programming cable,
- jumper,
- manual.

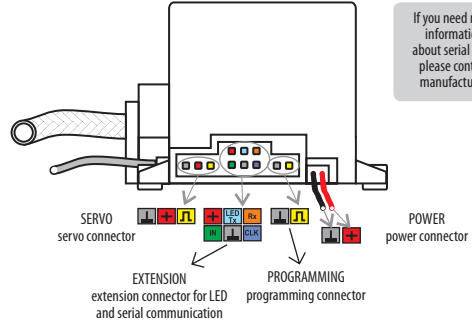

If you need more information about serial port, please contact manufacturer.

DESCRIPTION:

The ignition ICU-S and ICU-P offer special system "easy – start". This system simplifies engine starting thereby the ignition controls a choke valve. The choke is controlled by servo connected to the ignition. The ignition processor controls servo according to the program stored in memory. The most important benefit of this system is easy start procedure. After power-up and battery test (when enabled) only turning the propeller is needed for engine start. The "easy – start" system protects the engine from flooding or lean air-gasoline mixture when starting. After power-up and battery test (when enabled) the choke valve position is regulated by the ignition depending on propeller turning. When using "easy – start" system the ignition must learn both choke valve positions (open and closed). The type of silencer (preignition curve) must be set in programming mode, too.

BASIC FEATURES:

- automatic choke valve control,
- two preprogrammed preignition curves for ("short" – default setting and "long" silencer),
- one programmable preignition curve,
- sleep mode after 90 sec of engine inactivity,
- with or without battery test (for Li-Ion or Li-Pol battery),
- battery level signalization (it will not work if battery voltage is lower than 6,5 V (for S) and 9,5 (for P) and battery test feature is enabled),
- ignition goes off if engine runs counter clockwise.

TECHNICAL DATA:

Version	Standard	Professional
Weight	155 g	155 g
Power supply	2x LiIon / LiPol * 6x NiCd / NiMh *	3x LiIon / LiPol * 9x NiCd / NiMh * 8x NiCd / NiMh
Minimal battery voltage	6,5 V*	9,5 V*
<i>sleep mode after 90 sec of engine inactivity</i>		
<i>battery level signalization *</i>		
<i>ignition goes off if engine runs counter clockwise</i>		

verze	Standard	Professional
Enabling / disabling battery test	yes	yes
Enabling / disabling battery test	yes	yes
Customizing of preignition curve	yes	yes
Preignition point	5 °	5 °
Location of the magnet	240° / 120°	240° / 120°
Min. accumulator capacity	600 mAh	1 Ah

* if battery test is enabled

Never use ignition with unplugged boot from plug! Before first flight check range of controlling equipment with running engine as well do the interference check!

ENABLING OR DISABLING BATTERY

Ignition makes enable or disable battery test possible. **Battery test is very useful when Li-Pol or Li-Ion battery are used.** During the test a series of flashes are generated and voltage is measured. When test passed correctly, battery has energy for minimal 10 minutes of flight.

- battery test is disabled (default settings – when jumper is removed and programming pins are open),
- battery test is enabled – programming pins are closed by enclosed jumper).

Enable or disable battery test when the ignition is off.

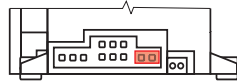

BATTERY TEST ENABLED:

- close programming pins with enclosed jumper.

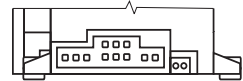

BATTERY TEST DISABLED:

- open programming pins (remove jumper).

INSTRUCTION – INSTALLATION AND POWER UP

If you want to change the type of silencer, do first all of two steps and then continue to the next page with title PROGRAMMING SEQUENCE. In the other case follow the next sequence.

FIRST STEP:

- screw on pickup on engine,
- attach the plastic protection to the high voltage cable,
- connect boot to plug,
- mount ring tongue terminal on the cable from boot (ring faston) under a nut holding the engine to the motor mount,
- fasten ignition to airplane.

SECOND STEP:

- connect enclosed LED to the ignition (red or red/black wire to left).

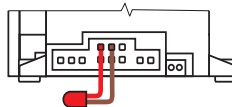

START:

- keep clear of the propeller,
- connect battery with the ignition box.

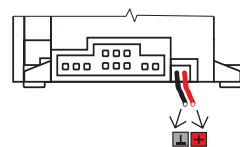

STARTING SEQUENCE:

- move propeller to open exhaust channel on engine (bottom center),
- **put your hands outside propeller radius, otherwise you risk serious injury,**
- hold on your airplane, switch on ignition,
- ignition starts battery test. During this test the series of sparks are generated for cca 5 sec and LED is blinking,
- if LED turns off, you can fly, otherwise battery is low.

PROGRAMMING SEQUENCE:

- Ignition needs to learn both positions of choke and type of silencer.
- firstly prepare ignition for programming (plug servo, plug programming cable to receiver, power up receiver, power up transmitter, power up ignition,
- secondly set close position of choke,
- thirdly set open position of choke,

- fourthly chose type of silencer,
- finally power off ignition, unplug programming cable and return throttle servo to receiver.

FIRST STEP:

- connect servo to servo connector.

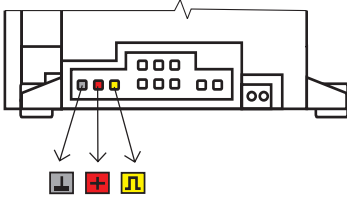

SECOND STEP:

- connect ignition to receiver (throttle channel) with enclosed cable,
- connect battery to receiver,
- switch on transmitter,
- set throttle to the centre.

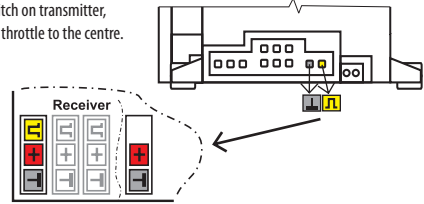

THIRD STEP:

- keep clear of the propeller,
- power up ignition.

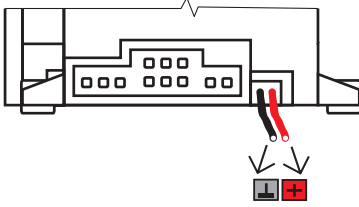

FOURTH STEP:

- move throttle stick until choke valve is completely closed,
- after approx. 5 sec without move, LED blink and choke will move its position to centre (PWM 1.5 ms) and after while it will return back.

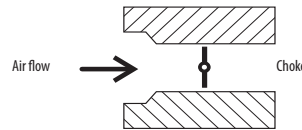

FIFTH STEP:

- move throttle stick until choke valve is completely open,
- after cca 5 sec without move, LED blink and choke will move its position to close and after while it will return back to open and close position.

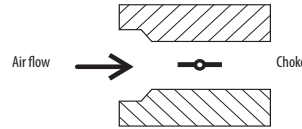

SIXTH STEP:

a) SHORT SILENCER SETUP

- don't move (at least 5 sec) the throttle stick (choke valve will still stay in open position), means the preignition curve for a short silencer is automatically installed, LED is blinking in short intervals.

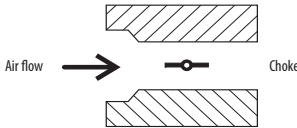

b) LONG SILENCER SETUP

- move the choke valve in closed position and wait at least 5 sec. Preignition curve for a long silencer is installed, LED is blinking in long intervals.

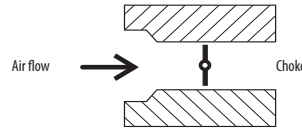

LAST STEP:

- power off ignition,
- power off receiver, unplug programming cable, return throttle servo to receiver,
- connect enclosed LED to the ignition (red or red/black wire to left).

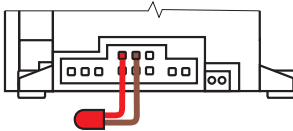

NORMAL OPERATION:

- power up ignition,
 - the rest is described in Starting sequence on previous page.
- Programming is necessary after first setting or when changing the preignition curve or type of silencer. It's not required to program the ignition before every start. If the "easy - start" function is not required the ignition programming is not necessary, the default setting is preignition curve for "short" silencer.*

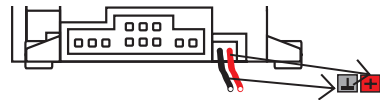

LED BLINKING INDICATION

Type	Problem	Solution
- fast blinking (after power up)	battery test is running	Wait a while.
- fast blinking (5sec after power up)	battery voltage is low	Charge battery. Voltage is lower than 6,5V (for S version) or 9,5V (for P version).
- one short flash per second	sleep mode spark is blocked	Unplug battery and reconnect it again.

PRODUCER:



MSR Engines s.r.o.
Nálepková 97
637 00 Brno / Czech
fax.: +420 545 210 903
e-mail: msrcz@tiscali.cz
www.msrengines.eu

WARNING!

- Use the ignition only in dry conditions,
- use recommended number and type of cells for every ignition type,
- the product is specified for RC engines only (other use must be approved by the manufacturer),
- do not take off the resistor cover if the ignition is on,

- danger of electric injury (voltage over 20 000 V),
- recharge ignition battery only outside the model,
- because of possible interferences, ignition and accumulators should be placed at least 25 cm from the receiver!

**The manufacturer is not responsible for damages caused by not following the manual and misuse the ignition other than in RC engines!
You will lost your guarantee if you damage the high voltage (HV) cable or HV isolation, pickup, reverse the batteries or open ignition box!**